

# TITAN

BY SCAGNELLATO & FERRARESE





Con TITAN, Cerantola espande la propria proposta nel campo della seduta ergonomica, arrivando ad un risultato che ben si adatta alle nuove tendenze del mondo dell'ufficio, pubblico, privato e dell'home office. L'obiettivo del progetto è stato quello di creare una sedia dal confort durevole, oggi sempre più richiesta a causa di lunghe sessioni di lavoro, che possa essere utilizzata sia nella propria postazione lavorativa che in lunghe sessioni di meeting. La principale caratteristica di questa seduta è quella di avere lo schienale regolabile in altezza, particolarità che, unita al supporto lombare e all'appoggiatesta anch'essi regolabili, consente di adattare le linee di sostegno delle zone lombari e cranio-sacrali a qualsiasi conformazione anatomica. Lo schienale viene offerto in due varianti principali: in rete o tappezzato. Quest'ultima versione viene sviluppata in due modelli, schienale posteriore in polipropilene oppure tappezzato. La vasta offerta di accessori permette poi di creare una generosa scelta di soluzioni che consentono a questo prodotto di spaziare da quella più esigente per un utilizzo direzionale a quella più accessibile per una opzione operativa. Tutte comunque unite da un comune gusto estetico, dall'agevole funzionalità della componentistica e dall'affidabilità dei materiali utilizzati.

With TITAN, Cerantola is expanding its product line into the field of ergonomic seating, with a chair that is suited to the new trends in the office world, both public and private. The goal of the project was to create a chair with lasting comfort, which is also required to withstand long work sessions. Whether you have to be sat at your desk or participate in long meeting sessions. The main features of Titan are the height adjustable backrest, lumbar support and adjustable headrest, allowing the user to adapt the support lines of the lumbar and cranio-sacral areas to any anatomical conformation. The backrest is offered with two main options: mesh or upholstered. The visual rear part of the upholstered backrest can be offered in either polypropylene or upholstered. The wide range of accessories then allows you to create a generous choice of solutions, which allow this product, to range from the most demanding for executive use to the most accessible for an operational option.

All however, united by a common aesthetic taste, with the easy functionality of the components and by the reliability of the materials used.

Con TITAN, Cerantola amplía su propuesta en el campo de los sillones direccionales ergonómicos, alcanzando un resultado que bien se adapta a las nuevas tendencias en el mundo de la oficina, tanto como institucional que como corporativa, y también en el "home office".

El objetivo del proyecto era desarrollar una silla con una comodidad duradera, que se requiere cada vez más en ocasiones de largas sesiones de trabajo, ya sea que uno tenga que enfocarse en su mismo escritorio o tener que participar en largas sesiones grupales. La característica principal de este artículo es que su respaldo tiene altura ajustable, una característica que, combinada con el soporte lumbar y el reposacabezas, también ajustables, le permite adaptar las líneas de soporte de las áreas lumbar y cráneo cervical a cualquier conformación anatómica. El respaldo se ofrece en dos variantes principales: malla o tapizado. Este último se puede diferenciar con otras dos versiones referentes a la parte trasera del respaldo, que pueden ser en polipropileno o también tapizadas. La amplia gama de accesorios crea una generosa selección de soluciones, que permite que este producto se ajuste a las necesidades más exigentes como para uso ejecutivo o necesidades más accesibles para una opción operativa.

Sin embargo, todas características compartidas en un gusto estético común, añadiendo también una fácil operatividad de los componentes y una confiabilidad de los materiales utilizados.















**COLORI PLASTICHE | PLASTIC COLORS | COLORES DE PLÁSTICO**

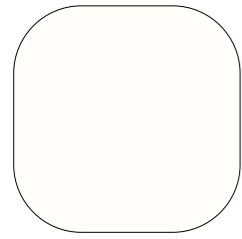

**BIANCO /  
WHITE / BLANCO  
RAL 9003**

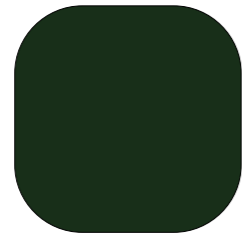

**NERO /  
BLACK / NEGRO  
RAL 9005**

**COLORE RETE | MESH COLORS | COLORES MALLA**

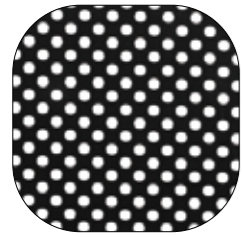

**NERO / BLACK /  
NEGRO**

**FINITURE BASI | BASES FINISHES | ACABADOS BASES**

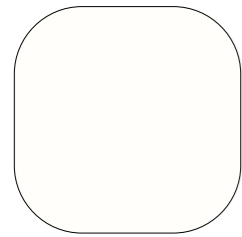

**BIANCO /  
WHITE / BLANCO  
RAL 9003**

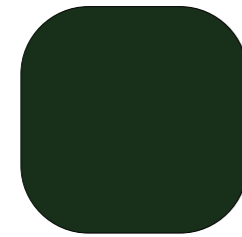

**NERO /  
BLACK / NEGRO  
RAL 9005**



**LUCIDO /  
POLISHED / PULIDO**

**DIMENSIONI | DIMENSIONS | MEDIDAS**

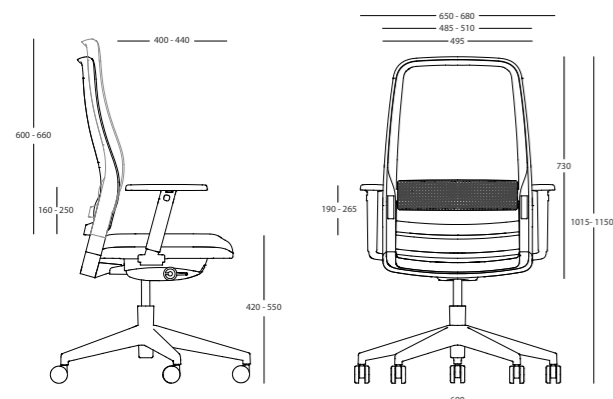

I colori campione presenti in queste pagine possono essere validi come riferimento indicativo. Per avere un riscontro preciso consigliamo di consultare i campioni colore reali.  
The colours are only to be considered as an indication of the real colour. To get a precise feedback you should consult the real colour samples.  
Los colores de la muestra en estas páginas pueden ser valiosos como guía de referencia. Para obtener una respuesta precisa deben consultar a las muestras reales de color.

SCHIENALI | BACKRESTS | RESPALDOS



**Da rivestire fronte e retro**  
To be upholstered front and back  
Para tapizar delante y detras



**Schienale in rete**  
Mesh backrest  
Respaldo en malla



**Da rivestire fronte**  
To be upholstered front  
Para tapizar delante

BRACCIOLI | ARMRESTS | BRAZOS



**BRC 20**



**BRC 24**



**BRC 28/28W**



**BRC 34**



**BRC 29/29W**



**BRC 29PU**



**BRC 30/30W**



**BRC 31/31W**



**BRC 31PU**



**BRC 35/35W**



**BRC 32/32W**



**BRC 32PU**



**BRC 33/33W**

BASI | BASES | BASES



**R34**



**R36N**

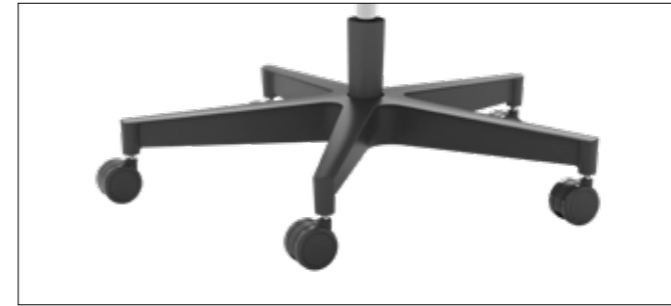

**R46 / R46W**



**R47**



**R48**



# TITAN

componenti kit - kit components - componentes kit

**SCHIENALI | BACKRESTS | RESPALDOS**

	TITAN/55 schienale Titan nero in rete   Titan black mesh backrest   respaldo Titan malla negro	<input type="radio"/>
	TITAN/55W schienale Titan bianco in rete nera   Titan white backrest black mesh   respaldo Titan blanco con malla negra	<input type="radio"/>
	TITAN/55SL08 schienale Titan nero in rete con supporto lombare   Titan black mesh backrest with lumbar support   respaldo Titan malla con soporte lumbar negro	<input type="radio"/>
	TITAN/55WSL08W schienale Titan bianco in rete nera con supporto lombare   Titan white backrest black mesh with lumbar support   respaldo Titan blanco malla negra con soporte lumbar blanco	<input type="radio"/>
	TITAN/54SUP esterno schienale superiore Titan nero per rete e tappezzeria   Titan upper black outer backrest for mesh and upholstery   externo respaldo Titan superior negro para malla y tapiceria	<input type="radio"/>
	TITAN/54WSUP esterno schienale superiore Titan bianco per rete e tappezzeria   Titan upper white outer backrest for mesh and upholstery   externo respaldo Titan superior blanco para malla y tapiceria	<input type="radio"/>
	TITAN/54INF esterno schienale inferiore Titan nero per rete e tappezzeria   Titan lower black outer backrest for mesh and upholstery   externo respaldo Titan inferior negro para malla y tapiceria	<input type="radio"/>
	TITAN/54WINF esterno schienale inferiore Titan bianco per rete e tappezzeria   Titan lower white outer backrest for mesh and upholstery   externo respaldo Titan inferior blanco para malla y tapiceria	<input type="radio"/>
	TITAN/53 interno schienale Titan nero da tappezzare   Titan black inner backrest for upholstery   interno respaldo Titan negro para tapizar	<input type="radio"/>
	TITAN/53W interno schienale Titan bianco da tappezzare   Titan white inner backrest for upholstery   interno respaldo Titan blanco para tapizar	<input type="radio"/>
	TITAN/57 interno schienale Titan nero per rete   Titan black inner backrest for mesh   interno respaldo Titan negro para malla	<input type="radio"/>
	TITAN/57W interno schienale Titan bianco per rete   Titan white inner backrest for mesh   interno respaldo Titan blanco para malla	<input type="radio"/>
	TITAN/59 carter schienale per imbottitura posteriore   backrest cover for back padding   cubierta por respaldo para tapiceria trasera	<input type="radio"/>

**SUPPORTI LOMBARI | LUMBAR SUPPORT | SOPORTE LUMBAR**

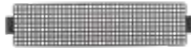
 **SL08**  
**kit supporto lombare regolabile in plastica nera | kit adjustable lumbar support in black plastic |**  
 kit soporte lumbar ajustable de plastico negro



**SL08W**  
**kit supporto lombare regolabile in plastica bianca | kit adjustable lumbar support in white plastic |**  
 kit soporte lumbar ajustable de plastico blanco



**SEDILI E SOTTOSEDILI | SEATS AND UNDER SEATS | ASIENTOS Y CUBRE ASIENTOS**

 **SI1018B**  
**sedile 18 borchie | inner seat 18 studs | interno asiento 18 tuercas**

 **SS13**  
**sottosedile in pp nero | black outer seat | cubre asiento negro**



**SS13W**  
**sottosedile in pp bianco | white outer seat | cubre asiento blanco**



**MECCANISMI | MECHANISMS | MECANISMOS**

 **MS08**  
**meccanismo epron sincron | synchro mechanism epron | mecanismo synchro epron**



**MS09**  
**meccanismo epron sincron con traslatore | synchro mechanism epron with seat adjustment | mecanismo**  
 synchro epron con regulador asiento



 **MS10**  
**meccanismo sincro | synchro mechanism | mecanismo synchro**



**MS11**  
**meccanismo sincron con traslatore | synchro mechanism with seat adjustment | mecanismo synchro con**  
 regulador asiento

**COLONNE A GAS | GAS LIFTS | PISTON DE GAZ**

 **G01**  
**colonna a gas dattilo 50x215 nera | black gas lift 50x215 | piston neumatico negro 50x215**



 **G03**  
**colonna a gas dattilo ribassata 50x215 nera | black lowered gas lift 50x215 |**  
 piston neumatico negro rebajado 50x215



**G03C**  
**colonna a gas dattilo ribassata 50x215 cromata | chromed lowered gas lift 50x215 |**  
 piston neumatico cromado rebajado 50x215



 **G08**  
**colonna a gas dattilo ribassata 50x215 nera | black lowered gas lift 50x215 |**  
 piston neumatico negro rebajado 50x215



**G08C**  
**colonna a gas dattilo ribassata 50x215 cromata | chromed lowered gas lift 50x215 |**  
 piston neumatico cromado rebajado 50x215



**BASI | BASES | BASES**

 **R34**  
**base in alluminio ø 690 | aluminum base ø 690 | base de aluminio ø 690**



 **R36N**  
**base poliammide ø 690 | polyamide base ø 690 | base de poliamide ø 690**



 **R46**  
**base poliammide ø 690 | polyamide base ø 690 | base de poliamide ø 690**



**R46W**  
**base poliammide bianca ø 690 | white polyamide base ø 690 | base de poliamide blanca ø 690**

 **R47**  
**base alluminio ø 690 | aluminum base ø 690 | base de aluminio ø 690**



 **R48**  
**base poliammide ø 700 | polyamide base ø 700 | base de poliamide ø 700**



**RUOTE | CASTORS | RUEDAS**

 **RT03**  
**ruota ø 50 p.11 nera | black castor ø 50 p.11 | rueda negra ø 50 p.11**



**RT05**  
**ruota ø 50 p.11 gommata nera | black rubber castor ø 50 p.11 | rueda negra ø 50 p.11 c/goma**

 **RT08**  
**ruota ø 60 p.11 gommata nera | black rubber castor ø 60 p.11 | rueda negra ø 60 p.11 c/goma**























 **RT09**  
**ruota ø 55 p.11 nera | black castor ø 55 p.11 | rueda negra ø 55 p.11**





















 **RT12**  
**ruota nera ø 60 p.11 | black castor ø 60 p.11 | rueda negra ø 60 p.11**



BRACCIOLI | ARMRESTS | BRAZOS

	BRC 20 <b>coppia braccioli triangolari</b>   triangular arms (couple)   juego brazos triangular	
	BRC 24 <b>coppia braccioli fissi in plastica</b>   black plastic arms (couple)   juego brazos de plastico negro	
	BRC 28 <b>coppia braccioli 2D regolabili in plastica</b>   2D black adjustable plastic arms (couple)   juego brazos ajustable 2D de plastico negro	
	BRC 28W <b>coppia braccioli 2D regolabili in plastica bianca</b>   2D white adjustable plastic arms (couple)   juego brazos ajustable 2D de plastico bianco	
	BRC 34 <b>coppia braccioli 2D regolabili in plastica con top chiuso</b>   2D black adjustable plastic arms (couple) with closed top   juego brazos ajustable 2D de plastico negro con tapa cerrada	
	BRC 34W <b>coppia braccioli 2D regolabili in plastica bianca con top chiuso</b>   2D white adjustable plastic arms (couple) with closed top   juego brazos ajustable 2D de plastico bianco con tapa cerrada	
	BRC 29 <b>coppia braccioli 3D regolabili in plastica nera</b>   3D black adjustable arms (couple)   juego brazos ajustable 3D de plastico negro	
	BRC 29W <b>coppia braccioli 3D regolabili in plastica bianca</b>   3D white adjustable arms (couple)   juego brazos ajustable 3D de plastico bianco	
	BRC 29PU <b>coppia braccioli 3D reg. in plast con copertina in PU</b>   3D black adjustable arms with PU top (couple)   juego brazos ajustable 3D plastico negro con el top en PU	
	BRC 30 <b>coppia braccioli 3D regolabili in plastica con top chiuso</b>   3D black adjustable plastic arms (couple) with closed top   juego brazos ajustable 3D de plastico negro con tapa cerrada	
	BRC 30W <b>coppia braccioli 3D regolabili in plastica bianca con top chiuso</b>   3D white adjustable plastic arms (couple) with closed top   juego brazos ajustable 3D de plastico bianco con tapa cerrada	

	BRC 31 <b>coppia braccioli 3D regolabili inclinati in plastica nera</b>   3D black adjustable arms (couple) in black plastic slope   juego brazos ajustable 3D de plastico negro inclinado	
	BRC 31W <b>coppia braccioli 3D regolabili inclinati in plastica bianca</b>   3D white adjustable arms (couple) in white plastic slope   juego brazos ajustable 3D de plastico bianco inclinado	
	BRC 31PU <b>coppia braccioli 3D regolabili inclinati in plastica con copertina PU</b>   3D black adjustable arms (couple) slope in plastic with PU top   juego brazos ajustable 3D inclinado de plastico con top en PU	
	BRC 35 <b>coppia braccioli 3D regolabili inclinati in plastica nera con top chiuso</b>   3D black adjustable arms (couple) in black plastic with closed top slope   juego brazos ajustable 3D de plastico negro con tapa cerrada inclinado	
	BRC 35W <b>coppia braccioli 3D regolabili inclinati in plastica bianca con top chiuso</b>   3D white adjustable arms (couple) with closed top slope   juego brazos ajustable 3D de plastico bianco con tapa cerrada inclinado	
	BRC 32 <b>coppia braccioli 3D regolabili inclinati in plastica nera con staffa in alluminio</b>   3D black adjustable arms (couple) in black plastic with aluminum bracket slope   juego brazos ajustable 3D de plastico negro con soporte de alluminio inclinado	
	BRC 32W <b>coppia braccioli 3D regolabili inclinati in plastica bianca con staffa in alluminio</b>   3D white adjustable arms (couple) with aluminum bracket slope   juego brazos ajustable 3D de plastico bianco con soporte de alluminio inclinado	
	BRC 32PU <b>coppia braccioli 3D regolabili inclinati in plastica con staffa in alluminio e copertina PU</b>   3D black adjustable arms (couple) in plastic with aluminum bracket and PU top slope   juego brazos ajustable 3D de plastico con soporte de alluminio y top en PU inclinado	
	BRC 33 <b>coppia braccioli 3D regolabili inclinati in plastica nera con staffa in alluminio e top chiuso</b>   3D black adjustable arms (couple) in black plastic with aluminum bracket and closed top slope   juego brazos ajustable 3D de plastico negro con soporte de alluminio y tapa cerrada inclinado	
	BRC 33W <b>coppia braccioli 3D regolabili inclinati in plastica bianca con staffa in alluminio e top chiuso</b>   3D white adjustable arms (couple) in white plastic with aluminum bracket and closed top slope   juego brazos ajustable 3D de plastico bianco con soporte de alluminio y tapa cerrada inclinado	

ACCESSORI PER BRACCIOLI | ACCESSORIES FOR ARMRESTS | ACCESORIOS PARA BRAZOS



ST19  
**staffa scorrimento per braccioli** | sliding bracket for armrest | soporte deslizante para brazos



CERN01  
**cerniera di ancoraggio staffa scorrimento braccioli** | anchor hinged sliding bracket arms | bisagra de enclaje soporte deslizante brazos



VLO4  
**volantino 30 mm** | wheel 30 mm | perilla 30 mm



APPOGGIATESTA | HEADREST | REPOSACABEZAS



APT01  
**pad poggiatesta da tappezzare** | headrest pad to be upholstered | pad reposacabezas para tapizar



BLAZE/58  
**kit connettore poggiatesta in plastica nera** | black plastic kit connector for headrest | kit conector plastico negro para reposacabezas



BLAZE/58W  
**kit connettore poggiatesta in plastica bianca** | white plastic kit connector for headrest | kit conector plastico blanco para reposacabezas



JEREMIAH FERRARESE

Nasce a Padova nel 1980 e si laurea in Architettura all'istituto IUAV di Venezia nel 2006. Nel 2005 inizia ad occuparsi di industrial design con particolare interesse al settore dell'arredo.

Born in Padua in 1980 and graduated in Architecture at IUAV Institute of Venice in 2006. In 2005 he began to work as an industrial designer with particular interest in the furniture industry.

Nace en Padua en el 1980 y se gradúa en arquitectura en el Instituto IUAV de Venecia en el 2006. En el 2005 inicia su actividad en diseño industrial con particular interés en el sector del mobiliario.



PAOLO SCAGNELLATO

Nasce a Padova nel 1952 e si laurea in Architettura a Venezia nel 1976 con relatore l'Arch. Aldo Rossi. Dal 1977 esercita la libera professione.

Born in 1952 in Padua, in 1976 he obtains the degree in Architecture in Venice, with Arch. Aldo Rossi as reference-man. In 1977 he begins his individual activity.

Nace en Padua en el 1952 y se gradúa en arquitectura en Venecia en 1976 con el director de tesis Arq. Aldo Rossi. En 1977 inicia su actividad como profesional independiente.

cerantola 



**CERANTOLA S.P.A.**

Via Giorgione, 2 - 31037 Ramon di Loria (TV) ITALY

Tel. + 39 0423 755 013 r.a. - Fax + 39 0423 755 152

[www.cerantola.com](http://www.cerantola.com) / [info@cerantola.com](mailto:info@cerantola.com)