

TIP TOP

BY SCAGNELLATO & FERRARESE





TIP TOP rappresenta l'evoluzione logica della seduta per collettività. Una seduta affidabile e robusta, disponibile nelle versioni a 4 gambe, 4 gambe su ruote, slitta, base girevole a 5 razze e panca. La profondità della gamma e la sua flessibilità è ulteriormente arricchita dalle numerose versioni in cui può essere configurata: in plastica, parzialmente o interamente tappezzata, con schienale in rete.

TIP TOP is the natural evolution of the chair for community. A solid and reliable solution, available in four-legs, four-legs on castors, cantilever, swivel star-base and bench. The width and flexibility of the range is enhanced by the many possible configurations available: entirely in plastic, partially or totally upholstered, with mesh back.

TIP TOP representa la evolución lógica de la silla por colectividad. Una silla confiable y resistente, disponible en versiones de 4 patas, 4 patas con rodajas, trineo, base giratoria con base de 5 puntas y bancada. La variedad de la gama y su flexibilidad de uso se ve reforzada por las numerosas versiones en las que se puede configurar: en PVC expuesto respaldo plástico asiento para tapizar, asiento y respaldo totalmente tapizado, con respaldo en malla

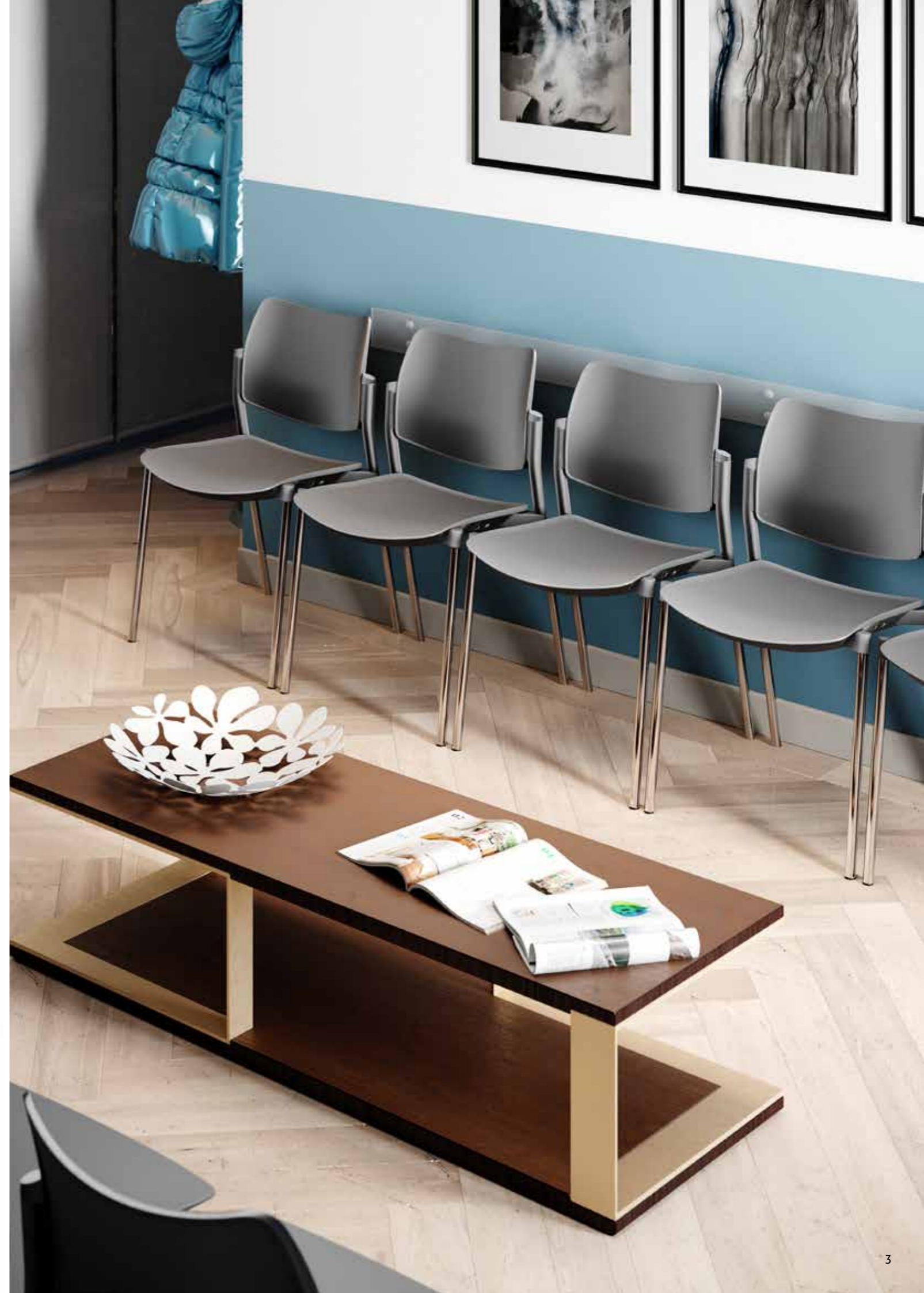







Fronte e retro schienale in plastica | Front and back plastic backrest | Respaldo anterior y posterior en plastico



Fronte schienale tappezzato, retro schienale tappezzato e in plastica | Upholstered backrest front, upholstered and plastic back | Anterior respaldo tapizado, posterior respaldo tapizado y en plastico



Fronte e retro schienale in rete | Front and back mesh backrest | Respaldo anterior y posterior en malla











COLORI PLASTICHE | PLASTIC COLORS | COLORES DE PLÁSTICO

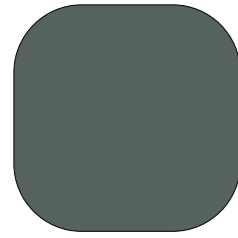

GRIGIO /
GREY / GRIS
RAL 7012

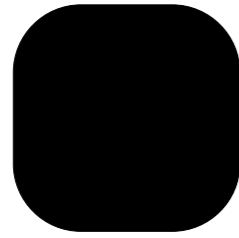

NERO /
BLACK / NEGRO
RAL 9005

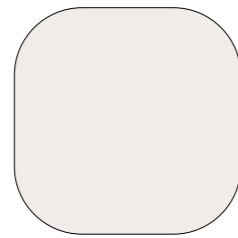

BIANCO /
WHITE / BLANCO
RAL 9003

FINITURE STRUTTURA | FRAME FINISHES | ACABADOS ESTRUCTURAS



BIANCO /
WHITE / BLANCO
RAL 9003



GRIGIO /
GREY / GRIS
RAL 7045



NERO /
BLACK / NEGRO
RAL 9005

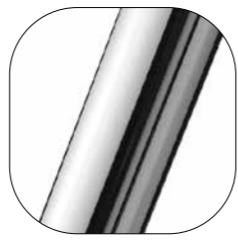

CROMO /
CHROME / CROMADO

DIMENSIONI | DIMENSIONS | MEDIDAS

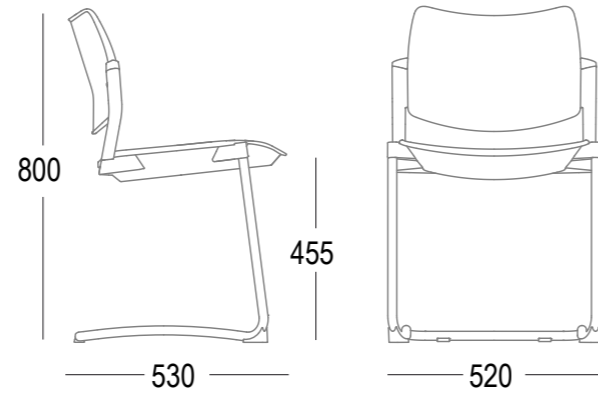
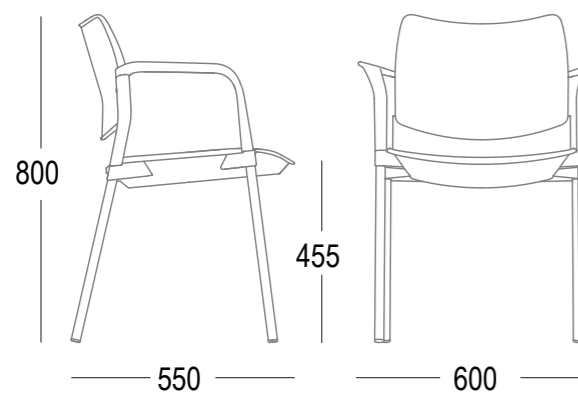
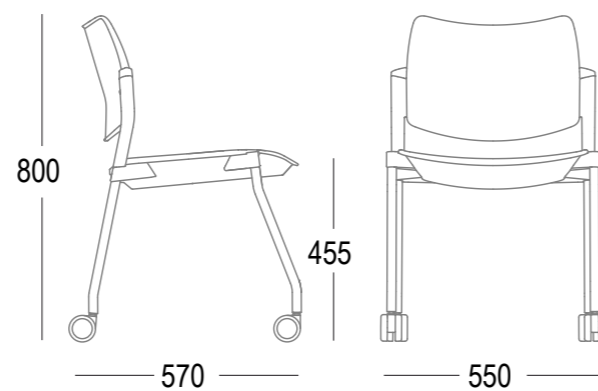
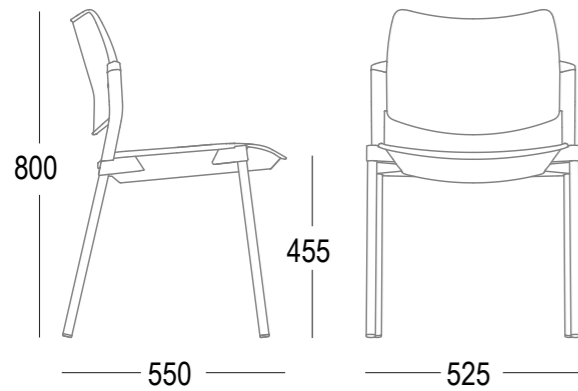

RETE | NET | MALLA

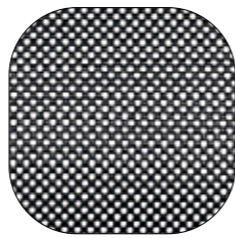

NERO /
BLACK / NEGRO

TIP TOP

componenti kit - kit components - componentes kit

SCHIENALI | BACKRESTS | RESPALDOS

VERSIONE PLASTICA | PLASTIC VERSION | VERSION PLÁSTICO



TIPTOP/24G
Schienale TipTop in plastica grigio | TipTop grey plastic backrest | Respaldo TipTop plástico gris



TIPTOP/24N
Schienale TipTop in plastica nero | TipTop black plastic backrest | Respaldo TipTop plástico negro



TIPTOP/24W
Schienale TipTop in plastica bianco | TipTop white plastic backrest | Respaldo TipTop plástico blanco



VERSIONE DA TAPPEZZARE | VERSION FOR UPHOLSTERY | VERSION PARA TAPIZAR



TIPTOP/53
Interno schienale nero TipTop da tappezzare | TipTop black inner backrest for upholstery | Interno respaldo negro TipTop para tapizar



TIPTOP/53W
Interno schienale bianco TipTop da tappezzare | TipTop white inner backrest for upholstery | Interno respaldo blanco TipTop para tapizar



TIPTOP/54
Esterno schienale nero TipTop da tappezzare e per rete | TipTop black outer backrest for upholstery and for mesh | Cubre respaldo negro TipTop para tapizar y para malla



TIPTOP/54W
Esterno schienale bianco TipTop da tappezzare e per rete | TipTop white outer backrest for upholstery and for mesh | Cubre respaldo blanco TipTop para tapizar y para malla



VERSIONE RETE | MESH VERSION | RESPALDO EN MALLA



TIPTOP/55
Schienale TipTop in rete nero | TipTop black mesh back | Respaldo TipTop en malla negro



TIPTOP/57
Interno schienale nero per rete TipTop | TipTop black inner backrest for mesh | Interno respaldo negro TipTop para malla



TIPTOP/57W
Interno schienale bianco per rete TipTop | TipTop white inner backrest for mesh | Interno respaldo blanco TipTop para malla



I colori campione presenti in queste pagine possono essere validi come riferimento indicativo. Per avere un riscontro preciso consigliamo di consultare i campioni colore reali.
The colours are only to be considered as an indication of the real colour. To get a precise feedback you should consult the real colour samples.
Los colores de la muestra en estas páginas pueden ser valiosos como guía de referencia. Para obtener una respuesta precisa deben consultar a las muestras reales de color.

SEDILI | SEATS | ASIENTOS

VERSIONE PLASTICA | PLASTIC VERSION | VERSION PLÁSTICO



TIPTOP/25G

Sedile TipTop in plastica grigio | TipTop grey plastic seat | Asiento TipTop plástico gris



TIPTOP/25N

Sedile TipTop in plastica nero | TipTop black plastic seat | Asiento TipTop plástico negro



TIPTOP/25W

Sedile TipTop in plastica bianco | TipTop white plastic seat | Asiento TipTop plástico blanco



VERSIONE DA TAPPEZZARE | VERSION FOR UPHOLSTERY | VERSION PARA TAPIZAR



TIPTOP/03

Interno sedile TipTop in plastica | TipTop plastic inner seat | Interno asiento TipTop en plastico



STEP/04

Esterno sedile in plastica nero | Black plastic outer seat | Cubre asiento en plastico negro



STEP/04G

Esterno sedile in plastica grigio | Grey plastic outer seat | Cubre asiento en plastico gris



STEP/04W

Esterno sedile in plastica bianco | White plastic outer seat | Cubre asiento en plastico blanco



STEP/34

Sottosedile nero per panca e girevole | Black outer seat for bench and swivel | Cubre asiento negro para bancada y giratoria



STEP/34G

Sottosedile grigio per panca e girevole | Grey outer seat for bench and swivel | Cubre asiento gris para bancada y giratoria



STEP/34W

Sottosedile bianco per panca e girevole | White outer seat for bench and swivel | Cubre asiento blanco para bancada y giratoria



STRUTTURE | FRAMES | ESTRUCTURAS



TIPTOP/05

Fusto Tiptop 4 gambe verniciato nero | Tiptop black 4 legs frame | Estructura Tiptop 4 patas negra



TIPTOP/06

Fusto Tiptop 4 gambe cromato | Tiptop chrome 4 legs frame | Estructura Tiptop 4 patas cromada



TIPTOP/07

Fusto Tiptop 4 gambe verniciato grigio | Tiptop grey 4 legs frame | Estructura Tiptop 4 patas gris



TIPTOP/35

Fusto Tiptop 4 gambe verniciato bianco | Tiptop white 4 legs frame | Estructura Tiptop 4 patas blanca pintada en blanco



TIPTOP/08

Fusto Tiptop a slitta verniciato nero | Tiptop black cantilever frame | Estructura Tiptop patin negra



TIPTOP/09

Fusto Tiptop a slitta cromato | Tiptop chrome cantilever frame | Estructura Tiptop patin cromada



TIPTOP/10

Fusto Tiptop a slitta verniciato grigio | Tiptop grey cantilever frame | Estructura Tiptop patin gris



TIPTOP/36

Fusto Tiptop a slitta verniciato bianco | Tiptop white cantilever frame | Estructura Tiptop patin blanco



TIPTOP/11

Fusto Tiptop per ruote verniciato nero | Tiptop black frame for castors | Estructura Tiptop para ruedas negra



TIPTOP/12

Fusto Tiptop per ruote cromato | Tiptop chrome frame for castors | Estructura Tiptop para ruedas cromada



TIPTOP/13

Fusto Tiptop per ruote verniciato grigio | Tiptop grey frame for castors | Estructura Tiptop para ruedas gris



TIPTOP/14

Fusto Tiptop per panca e girevole verniciato nero | Tiptop black frame for bench and swivel | Estructura Tiptop para bancada y giratoria negra



KYOS/17

Set tappo nero per schienale | Set black plugs for back | Set tapones en negro para respaldo



KYOS/17G

Set tappo grigio per schienale | Set grey plugs for back | Set tapones en gris para respaldo



KYOS/17W

Set tappo bianco per schienale | Set white plugs for back | Set tapones en blanco para respaldo



STEP/18

Set coprisaldatura in plastica nera | Set black plastic cover welding | Set cubre-soldadura en plastico negro



STEP/18G

Set coprisaldatura in plastica grigia | Set grey plastic cover welding | Set cubre-soldadura en plastico gris



STEP/18W

Set coprisaldatura in plastica bianca | Set white plastic cover welding | Set cubre-soldadura en plastico blanca



STEP/60

Set coprisaldatura nera per braccioli | Set black plastic cover welding for armrests | Set cubre-soldadura negra para brazos



STEP/60G

Set coprisaldatura grigia per braccioli | Set grey plastic cover welding for armrests | Set cubre-soldadura gris para brazos



STEP/60W

Set coprisaldatura bianca per braccioli | Set white plastic cover welding for armrests | Set cubre-soldadura blanco para brazos

















STEP/61















Set adattatore panca e slitta | Adapter set for bench and slide | Juego adaptador para banco y patin



























BRACCIOLI | ARMRESTS | BRAZOS

	KYOS/20-21 Coppia braccioli in plastica neri Couple black plastic armrests Juego brazos en plastico negro	
	KYOS/20-21G Coppia braccioli in plastica grigi Couple grey plastic armrests Juego brazos en plastic gris	
	KYOS/20-21W Coppia braccioli in plastica bianchi Couple white plastic armrests Juego brazos en plastico blanco	
	KYOS/20-23 Coppia braccioli con tavoletta sinistra Couple of armrests with left writing tablet Juego brazos con pala escritorio izquierda	
	KYOS/21-22 Coppia braccioli con tavoletta destra Couple of armrests with right writing tablet Juego brazos con pala escritorio derecha	
	KYOS/56 Bracciolo destro in alluminio con tavoletta Right aluminum armrest with writing tablet Brazo derecho de aluminio con pala escritorio	 
	KYOS/21 Bracciolo sinistro in plastica nero Left armrest in black plastic Brazo izquierdo en plastico negro	







ACCESSORI | ACCESSORIES | ACCESORIOS

	P18 piastra gas alluminio aluminum gas plate plasto de gas en aluminio	
	G03C colonna a gas chrome gas lift piston de gaz cromado	
	R35 Base in alluminio lucido d.650 Polished aluminum base d.650 Base en em aluminio puido d.650	
	RT09 Ruota d.50 p.11 nera Black castor d.50 pin 11 Rueda negra d.50 pivot 11	
	RT07G Ruota d.60 p.10 grigia gommata Grey rubber castor d.60 pin 11 Rueda gris d.60p.11 con goma	
	RT07N Ruota d.60 p.10 nera gommata Black rubber castor d.60 pin 11 Rueda negra d.60p.11 con goma	
	STEP/31 Set aggancio unione nero Black linking device set Set enganche de union negr	



























COMPONENTI PANCA | BENCH COMPONENTS | COMPONENTES BANCADA

	D07 Adattatore nero per panca in alluminio Black adapter for gp02 Adaptador negro para gp02	
	D07A Adattatore grigio per panca in alluminio Grey adapter for gp02a Adaptador gris para gp02a	
	D09 Adattatore per panca in alluminio fissa Adapter for gp03n Adaptator para gp03n	
	GP02 Gamba per panca in alluminio Polished aluminum bench leg Pata para bancada en aluminio lucido	
	GP02A Gamba per panca in alluminio verniciata grigia Grey painted aluminum bench leg Pata para bancada en aluminium pintada gris	
	GP03N Gamba per panca in alluminio verniciata nera fissa Black painted aluminum fixed bench leg Pata para bancada fija pintada negra	
	GP04 Gamba panca in nylon Nylon bench leg Pata para bancada en nylon	
	ST13 staffa di fissaggio per telaio panca da 80x40 support bracket for bench frame 80x40 bracket fijador para estructura bancada 80x40	
	TRA05 trave tubo rettangolare 80x40x1020 2 posti 2-place rectangular tube beam 80x40x1020 viga rectangular 80x40x1020 2 asientos	
	TRA06 trave tubo rettangolare 80x40x1600 3 posti 3-place rectangular tube beam 80x40x1600 viga rectangular 80x40x1600 3 asientos	
	TRA07 trave tubo rettangolare 80x40x2040 4 posti 4-place rectangular tube beam 80x40x2040 viga rectangular 80x40x2040 4 asientos	
	TRA08 trave tubo rettangolare 80x40x2550 5 posti 5-place rectangular tube beam 80x40x2550 viga rectangular 80x40x2550 5 asientos	



ACCESSORI PANCA | BENCH ACCESSORIES | BENCH ACCESORIES

	BRC23 Bracciolo nero universale per panca Black universal armrest for bench Brazo negro universal para bancada	
	ST14 Staffa di fissaggio per tavolino panca Fixing bracket for bench table Bracket fijador para mesa bancada	
	TA01 Tavolo per panca Bench table Mesa para bancada	

VITI E TAPPI | SCREWS AND PLUGS | TORNILLOS Y TAPONES

	SUP07 Supporto in plastica per ruota RT07 Plastic support for castors RT07 Tapon en plastico para rueda RT07	
	TP10 Tappo puntuale diametro 22 Plug d.22 Tapon d.22	
	TP17 Kit 4 tappi per slitta diametro 22 e diametro 25 Kit 4 plugs for slide frame d.22 & d.25 Kit 4 tapones para patin d.22 & d.25	
	VT12 Vite 4.8x13 autofilettante Self-tapping screw 4.8x13 Tornillo tfr 4.8x13	
	VT13 Vite M6x14 Screw m6x14 Tornillo tcl cabeza ancha 6ma x 14 mm	
	VT18 Vite M8x16 Screw m8x16 Tornillo tcc alen 8ma x16	
	VT20 Vite 6x22 autofilettante Self-tapping screw 6x22 Tornillos 6x22	
	VT27 Vite 4.5x12 autofilettante Self-tapping screw 4.5x12 Tornillo tfr 4.5x12	
	VT27N Vite 4.5x12 autofilettante zincata nera Black self-tapping screw 4.5 x 12 Tornillo negro autoroscante 4.5 x 12	
	VT34 Vite 3.9x9.5 autoforante zincata bianca Self-tapping screw 3,9x9,5 Tornillo autoroscante 3.9x9.5	
	VT37 Vite 4x16 autofilettante zincata nera Black self-tapping screws 4x16 Tornillo negro autoroscante 4x16	
	VT38 Vite 4x16 autofilettante zincata bianca Self-tapping screws 4x16 Tornillo autoroscante 4x16	
	TP15 Tappo paracolpi in PVC trasparente Plug anti-shock PVC transparent Tapon en PVC trasparente	

CARRELLO | TROLLEY | CARRITO

	CARRELLO01/KD Carrello portasedie universale Universal trolley for chairs Carrito portasilas universal	
---	---	---



JEREMIAH FERRARESE

Nasce a Padova nel 1980 e si laurea in Architettura all'istituto IUAV di Venezia nel 2006. Nel 2005 inizia ad occuparsi di industrial design con particolare interesse al settore dell'arredo.

Born in Padua in 1980 and graduated in Architecture at IUAV Institute of Venice in 2006. In 2005 he began to work as an industrial designer with particular interest in the furniture industry.

Nace en Padua en el 1980 y se gradúa en arquitectura en el Instituto IUAV de Venecia en el 2006.

En el 2005 inicia su actividad en diseño industrial con particular interés en el sector del mobiliario.



PAOLO SCAGNELLATO

Nasce a Padova nel 1952 e si laurea in Architettura a Venezia nel 1976 con relatore l'Arch. Aldo Rossi. Dal 1977 esercita la libera professione.

Born in 1952 in Padua, in 1976 he obtains the degree in Architecture in Venice, with Arch. Aldo Rossi as reference-man. In 1977 he begins his individual activity.

Nace en Padua en el 1952 y se gradúa en arquitectura en Venecia en 1976 con el director de tesis Arq. Aldo Rossi. En 1977 inicia su actividad como profesional independiente.

cerantola 



CERANTOLA S.P.A.

Via Giorgione, 2 - 31037 Ramon di Loria (TV) ITALY
Tel. + 39 0423 755 013 r.a. - Fax + 39 0423 755 152
www.cerantola.com / info@cerantola.com