

NIK

BY SCAGNELLATO & FERRARESE





La sedia NIK può essere fornita nelle seguenti varianti: su fusto a quattro gambe, quattro gambe su ruote, slitta e panca in varie lunghezze. In ciascuno di questi casi è disponibile con o senza braccioli. Nella versione completamente tappezzata, lo schienale può essere rivestito su entrambi i lati oppure solo frontalmente con il lato posteriore in plastica. Un'ulteriore opzione è lo schienale in rete. NIK è dunque una soluzione ideale sia per ambienti ufficio che contract, quali sale d'attesa, meeting e conferenza. Il comfort non è l'unica caratteristica di NIK: la sua versatile funzionalità si combina con la resistenza e con l'elevata affidabilità verificata dai test previsti dalle norme internazionali.

The NIK chair can be supplied in different varieties: on a four-legged frame, four-legged frame on castors, sled and bench on several lengths. In any of these cases, it is available with or without armrests. In the upholstered version, the backrest can be covered on both sides or only on the front, with backside in plastic. An additional option is the mesh backrest. NIK is an ideal solution both for office and for contract environments, as waiting, meeting and conference areas. Besides comfort NIK has got other features: its versatile functionality combines with resistance and reliability in compliance with the international standards.

Nik es una silla que puede ser surtida en diferentes versiones: cuatro patas fija, cuatro patas giratoria con rodaja, con patín (todas disponibles con o sin brazos) y para bancada de diferentes tamaños. El asiento se entrega siempre en versión para tapiz, mientras el respaldo puede ser surtido en versión tapizada o versión en malla. En este último caso el reverso del respaldo puede ser en plástico o también tapizado. Gracias a todo esto, Nik se propone como una propuesta válida por la mayoría de los espacios, como su uso para oficina y para el contract, para la visita y la salas de espera gracias también a sus alternativas cuales los brazos y brazo con paleta anti-pánico. El alto nivel de confort no es la única característica de Nik: su versatilidad y su durabilidad comprobada por medio de las pruebas más severas previstos por las normas internacionales hacen de este producto un artículo garantizado y confiable.











Fronte e retro schienale in rete | Mesh front and back | respaldo en malla en ambos lados



Fronte e retro schienale rivestiti | Upholstered front and back | respaldo tapizado en frente y atrás



Fronte rivestito e retro schienale in plastica | Upholstered front and plastic back | respaldo tapizado en frente y plástico al revés







COLORI PLASTICHE | PLASTIC COLORS | COLORES DE PLÁSTICO

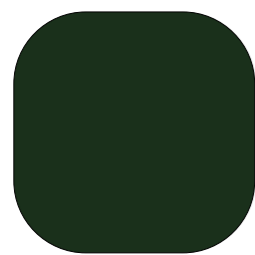

NERO / BLACK / NEGRO
RAL 9005

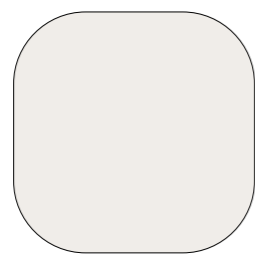

BIANCO / WHITE / BLANCO
RAL 9003

COLORE RETE | MESH COLOR | COLOR MALLA

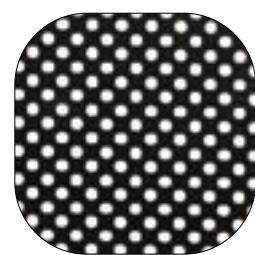

NERO / BLACK / NEGRO

COLORI STRUTTURE | METAL FRAMES COLORS | ACABADOS ESTRUCTURAS



NERO / BLACK / NEGRO
RAL 9005



GRIGIO / GREY / GRIS
RAL 7045



CROMO / CHROME / CROMADO

DIMENSIONI | DIMENSIONS | MEDIDAS

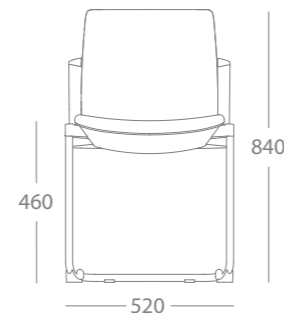
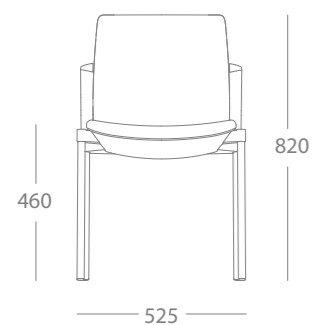

NIK

componenti kit - kit components - componentes kit

SCHIENALI | BACKRESTS | RESPALDOS

VERSIONE RETE | MESH VERSION | VERSION DE MALLA



KYOS/55
schienale Nik rete nera | backrest Nik with black mesh | respaldo Nik con malla negra



ESTERNO SCHIENALE | OUTER BACKREST | RESPALDO ESTERNO

VERSIONE RETE / PER TAPPEZZERIA | MESH AND UPHOLSTERY VERSION | VERSIONE DE MALLA Y PARA TAPIZAR



KYOS/54
esterno schienale Nik nero per rete / da tappezzare | black outer backrest Nik mesh or upholstery | respaldo esterno negro Nik para malla y tapiceria



KYOS/54W
esterno schienale Nik bianco per rete / da tappezzare | white outer backrest Nik mesh or upholstery | respaldo esterno bianco Nik para malla y tapiceria



INTERNO SCHIENALE | INNER BACKREST | RESPALDO INTERNO

VERSIONE PER TAPPEZZERIA | FOR UPHOLSTERY VERSION | VERSION PARA TAPIZAR



KYOS/53
interno schienale Nik plastica nera da tappezzare | black inner backrest Nik for upholstery | respaldo interno negro Nik para tapizar



KYOS/53W
interno schienale Nik plastica bianca da tappezzare | white inner backrest Nik for upholstery | respaldo interno bianco Nik para tapizar



VERSIONE PER RETE | VERSION FOR MESH | VERSION PARA MALLA



KYOS/57
interno schienale Nik plastica nera per rete | black inner backrest Nik for mesh | respaldo interno negro Nik para malla



KYOS/57W
interno schienale Nik plastica bianca per rete | white inner backrest Nik for mesh | respaldo interno negro Nik para malla



I colori campione presenti in queste pagine possono essere validi come riferimento indicativo. Per avere un riscontro preciso consigliamo di consultare i campioni colore reali.
The colours are only to be considered as an indication of the real colour. To get a precise feedback should consult the real colour samples.
Los colores de la muestra en estas páginas pueden ser valiosos como guía de referencia. Para obtener una respuesta precisa deben consultar a las muestras reales de color.

SEDILI | SEATS | ASIENTOS

VERSIONE PER TAPPEZZERIA | FOR UPHOLSTERY VERSION | VERSION PARA TAPIZAR



STEP/03
interno sedile Step/Kyos in plastica | Step/Kyos plastic inner seat | asiento interior Step/Kyos en plastico



ESTERNO SEDILE | OUTER SEAT | ASIENTO ESTERNO



STEP/04
esterno sedile Step/Kyos in plastica nero | Step/Kyos black plastic outer seat | asiento externo Step/Kyos en plastico negro



STEP/04W
esterno sedile Step/Kyos in plastica bianco | Step/Kyos white plastic outer seat | asiento externo Step/Kyos en plastico bianco



VERSIONE PANCA/GIREVOLE | BENCH/SWIVEL VERSION | VERSION BANCADA/GIRATORIA



STEP/34
sottosedile Step/Kyos nero per panca | Step/Kyos black outer seat for bench | cubre asiento Step/Kyos negro para bancada



STEP/34W
sottosedile Step/Kyos bianco per panca | Step/Kyos white outer seat for bench | cubre asiento Step/Kyos bianco para bancada



STRUTTURE | FRAMES | ESTRUCTURAS



KYOS/05
fusto Kyos 4 gambe verniciato nero | Kyos black 4 legs frame | estructura 4 patas pintada negro Kyos



KYOS/06
fusto Kyos 4 gambe cromato | Kyos chrome 4 legs frame | estructura cromada 4 patas Kyos



KYOS/07
fusto Kyos 4 gambe verniciato grigio | Kyos grey 4 legs frame | estructura 4 gris patas en Kyos



KYOS/35
fusto Kyos 4 gambe verniciato bianco | Kyos white 4 legs frame | estructura blanco 4 patas Kyos



KYOS/08
fusto Kyos a slitta verniciato nero | Kyos black cantilever frame | estructura patin negro Kyos



KYOS/09
fusto Kyos a slitta cromato | Kyos chrome cantilever frame | estructura patin cromada Kyos



KYOS/10
fusto Kyos a slitta verniciato grigio | Kyos grey cantilever frame | estructura patin en gris Kyos



KYOS/36
fusto Kyos a slitta verniciato bianco | Kyos white cantilever frame | estructura patin bianco Kyos



KYOS/11
fusto Kyos per ruote verniciato nero | Kyos black frame for castors | estructura negra para ruedas Kyos



KYOS/12
fusto Kyos per ruote cromato | Kyos chrome frame for castors | estructura cromada para ruedas Kyos



KYOS/13
fusto Kyos per ruote verniciato grigio | Kyos grey frame for castors | estructura en gris para ruedas Kyos



STRUTTURA PER PANCA | BENCH FRAMES | ESTRUCTURA PARA BANCADAS
 KYOS/14
fusto per panca Kyos verniciato nero | black frame Kyos for bench | estructura para bancada Kyos negra



COMPONENTI MONTAGGIO | ASSEMBLING COMPONENTS | COMPONENTES PARA EL MONTAJE



KYOS/17
set tappo nero per schienali Kyos | kit black plugs for Kyos back | set tapones en negro para respaldo Kyos



KYOS/17W
set tappo bianco per schienali Kyos | kit white plugs for Kyos back | set tapones en blanco para respaldo Kyos



STEP/18
set coprisaldatura Step in plastica nera | set black plastic cover welding | set cubre-soldadura Step en plastico nera (4pz)



STEP/18W
set coprisaldatura Step in plastica bianca | set white plastic cover welding | set cubre-soldadura Step en plastico bianca (4pz)



STEP/60
set coprisaldatura nera per braccioli | set black plastic cover welding for armrests | set cubre-soldadura negra para braccioli (4pz)





STEP/60W
set coprisaldatura bianca per braccioli | set white plastic cover welding for armrests | set cubre-soldadura bianco para braccioli (4pz)









STEP/61
set adattatore panca e slitta Step/Kyos (4pz) | adapter set for bench and slide Step/Kyos (4pz) | juego adapt.para banco y patin Step/Kyos (4pz)







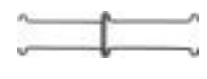























BRACCIOLI | ARMRESTS | BRAZOS

	KYOS/20-21 coppia braccioli Kyos neri couple Kyos black armrests juego brazos negro Kyos	
	KYOS/20-21W coppia braccioli Kyos bianchi couple Kyos white armrests juegos brazos blancos Kyos	
	KYOS/21 bracciolo sinistro Kyos in plastica left Kyos plastic armrest brazo izquierdo Kyos en plastico	
	KYOS/56 bracciolo destro Kyos in alluminio con tavoletta righ Kyos aluminum armrest with writing tablet brazo derecho de aluminio Kyos con mesa	

ACCESSORI | ACCESSORIES | ACCESORIOS

	RT07G ruota D.60 P.10 grigia gommata grey rubber castor d.60 pin 11 rueda gris d.60p.11 c/goma	
	RT07N ruota D.60 P.10 nera gommata black rubber castor d.60 pin 11 rueda negra d.60p.11 c/goma	
	STEP/31 Set aggancio unione Step/Kyos verniciato nero Step/Kyos black linking device set enganche de union Step pintado negro	

COMPONENTI PANCA | BENCH COMPONENTS | COMPONENTES PARA BANCADA

	D03 adattatore nero per panca in alluminio adapter for gp02 adaptador para gp02	
	D03A adattatore grigio per panca in alluminio adapter for gp02a adaptador para gp02a	
	D04 adattatore per panca in alluminio fissa adapter for gp03n adaptador para gp03n	
	GP01 gamba per panca cromata chromed leg for bench pata para banco cromada	
	GP01A gamba per panca grigio alluminio grey leg for bench pata para banco alluminio	
	GP01N gamba per panca nera black leg for bench pata para banco negra	
	GP02 gamba per panca in alluminio polished aluminum bench leg pata para bancada en aluminio lucido	
	GP02A gamba per panca in alluminio verniciata grigia grey painted aluminum bench leg pata para bancada en aluminium pintada gris	
	GP03N gamba per panca in alluminio verniciata nera fissa black painted aluminum fixed bench leg pata para bancada fija pintada negra	
	GP04 gamba per panca in nylon nylon bench leg pata bancada en nylon	
	ST12 staffa di fissaggio per telaio panca support bracket for bench frame bracket fijador para banco	
	ST13 staffa di fissaggio per telaio panca da 40 support bracket for bench frame d.40 bracket fijador para banco d.40	
	TRA01 trave tubo rettangolare 80x20x1020 2 posti 2-place rectangular tube beam 80x30x1020 viga tubo rettangolare 80x30x1020 2asientos	
	TRA02 trave tubo rettangolare 80x30x1600 3 posti 3-place rectangular tube beam 80x30x1600 viga tubo rettangolare 80x30x1600 3 asientos	
	TRA03 trave tubo rettangolare 80x30x2040 4 posti 4-place rectangular tube beam 80x30x2040 viga tubo rettangolare 80x30x2040 4 asientos	
	TRA04 trave tubo rettangolare 80x30x2550 5 posti 5-place rectangular tube beam 80x30x2550 viga tubo rettangolare 80x30x2550 5 asientos	

TRA05
trave tubo rettangolare 80x40x1020 2 posti | 2-place rectangular tube beam 80x40x1020 | viga rectangular 80x40x1020 2 asientos



TRA06
trave tubo rettangolare 80x40x16000 3 posti | 3-place rectangular tube beam 80x40x1600 | viga rectangular 80x40x1600 3 asientos



TRA07
trave tubo rettangolare 80x40x2040 4 posti | 4-place rectangular tube beam 80x40x2040 | viga rectangular 80x40x2040 4 asientos



TRA08
trave tubo rettangolare 80x40x2550 5 posti | 5-place rectangular tube beam 80x40x2550 | viga rectangular 80x40x2550 5 asientos



BRACCIOLO UNIVERSALE PER PANCA | UNIVERSAL ARMREST FOR BENCH | BRAZO BANCADA

BRC23
bracciolo nero per panca | bench armrest | brazo para bancada



ACCESSORI PER PANCA | BENCH ACCESSORIES | ACCESORIOS PARA BANCADA

ST14
staffa di fissaggio per tavolino panca | fixing arm rack bands for bench table | bracket fijador p/mesa banco



TA01
tavolino per panca | bench table | mesa para banco



VITI E TAPPI | SCREWS AND PLUGS | TORNILLOS Y TAPONES

SUP07
supporto in plastica diametro 10 per RT07 | support for castors rt07 | tapones para rueda rt07



TP10
tappo puntuale diametro 22 | plug d.22 | tapon d.22 negro



TP17
kit 4 tappi per slitta diametro 22 e diametro 25 | kit 4 plugs for slide frame d.22 & d.25 | kit 4 tapones para patin d.22 & d.25



VT12
vite 4,8x13 autofilettante | self-tapping screw 4,8x13 | tornillo tfr 4,8x13



VT13
vite M6x14 | screw m6x14 | tornillo tbl cabeza ancha 6ma x 14 mm



VT18
vite M8x16 | screw m8x16 | tornillo tce alen 8ma x16 asiento banca



VT20
vite 6x22 autofilettante | self-tapping screw 6x22 | tornillos 6x22



VT27
vite 4,5x12 autofilettante | self-tapping screw 4x12 | tornillo tfr 4x12



VT27N
vite 4,5x12 autofilettante zincata nera | black self-tapping screw 4,5 x 12 | tornillo negro autoroscante 4,5 x 12



VT34
vite 3,9x9,5 autoforante zincata bianca | self-tapping screw 3,9x9,5 | tornillo autoroscante 3,9x9,5



VT37
vite 4x16 autofilettante zincata nera | black self-tapping screws 4x16 to fix the back with the | tornillo negro autoroscante 4x16



VT38
vite 4x16 autofilettante zincata bianca | self-tapping screws 4x16 to fix the | tornillo autoroscante 4x16





JEREMIAH FERRARESE

JEREMIAH FERRARESE

Nasce a Padova nel 1980 e si laurea in Architettura all'istituto IUAV di Venezia nel 2006. Nel 2005 inizia ad occuparsi di industrial design con particolare interesse al settore dell'arredo.

Born in Padua in 1980 and graduated in Architecture at IUAV Institute of Venice in 2006. In 2005 he began to work as an industrial designer with particular interest in the furniture industry.

Nace en Padua en el 1980 y se gradúa en arquitectura en el Instituto IUAV de Venecia en el 2006.

En el 2005 inicia su actividad en diseño industrial con particular interés en el sector del mobiliario.



PAOLO SCAGNELLATO

Nasce a Padova nel 1952 e si laurea in Architettura a Venezia nel 1976 con relatore l'Arch. Aldo Rossi. Dal 1977 esercita la libera professione.

Born in 1952 in Padua, in 1976 he obtains the degree in Architecture in Venice, with Arch. Aldo Rossi as reference-man. In 1977 he begins his individual activity.

Nace en Padua en el 1952 y se gradúa en arquitectura en Venecia en 1976 con el director de tesis Arq. Aldo Rossi. En 1977 inicia su actividad como profesional independiente.



cerantola 



CERANTOLA S.P.A.

Via Giorgione, 2 - 31037 Ramon di Loria (TV) ITALY
Tel. + 39 0423 755 013 r.a. - Fax + 39 0423 755 152
www.cerantola.com / info@cerantola.com